

MEGA 200

Monocrystalline Solar Panel

200W

Maximum Power Output

32 CELLS

Monocrystalline Module

0~+5W









Positive Power Tolerance

19.7%

Maximum Efficiency



FEATURES

-  9 busbar solar cell configuration
-  Lightweight anodized aluminum frame
-  Plug and play junction box
-  High transmission, AR (anti-reflective) coated tempered glass
-  Industry standard quick connect cables (Solar Connectors) work in series or in parallel
-  Excellent low light performance on cloudy days, mornings and evenings
-  Highly reliable due to stringent quality control (Over 30 in-house tests (UV, TC, HF, and many more), PID resistant, 100% EL double inspection)
-  Certified to withstand challenging environmental conditions (2400 Pa wind load, 5400 Pa snow load, 35 mm hail stones at 97 km/h)

INSTALLATION

Easy installation and handling for various applications (high-end off-grid and mobile applications).

Pre-drilled holes compatible with ground mounts, Z brackets, pole mounts and tilt mounts.

Compatible with on-grid and off-grid inverters.

WARRANTY

25 years warranty limited output power

* (Please refer to product warranty for details)

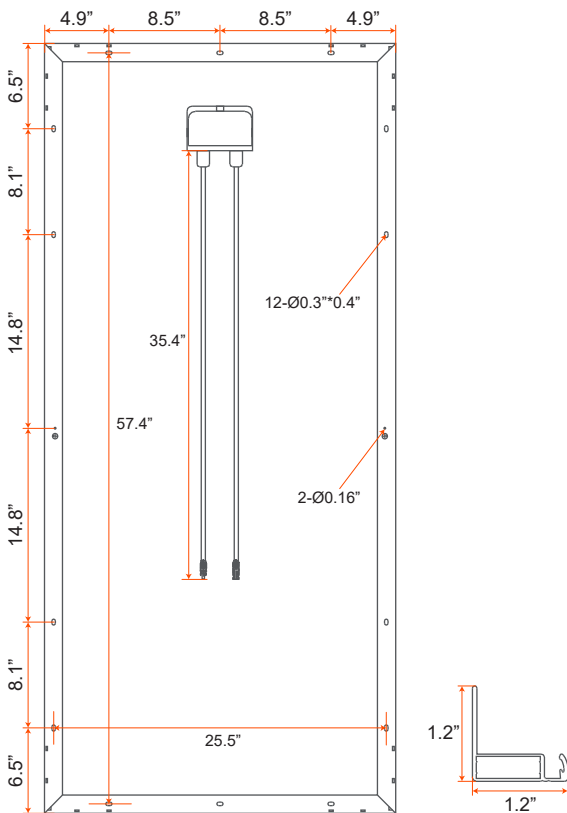
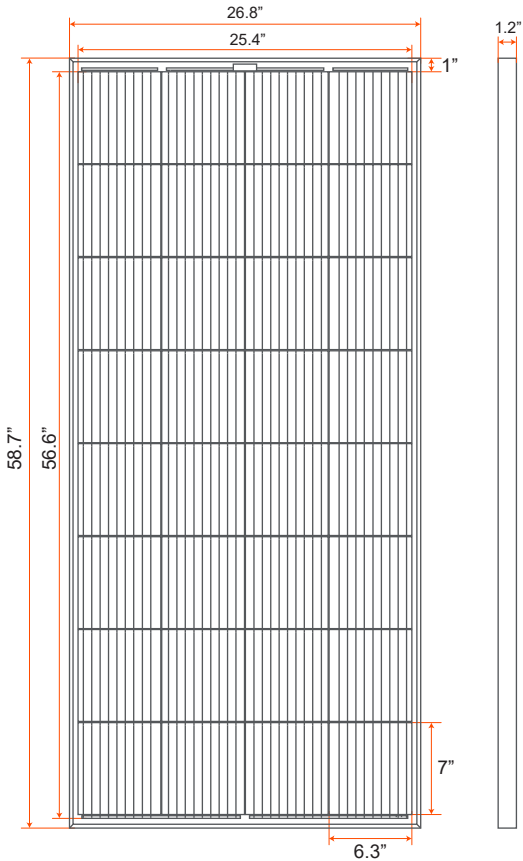

ELECTRICAL DATA (STC)

Peak Power Watts-PMAX (Wp)	200 W
Power Output Tolerance-PMAX (W)	0~+5 W
Maximum Power Voltage-VMPP (V)	18.4 V
Maximum Power Current-IMPP (A)	10.9 A
Open Circuit Voltage-VOC (V)	21.8 V
Short Circuit Current-ISC (A)	11.6 A
Maximum System Voltage	1500 VDC
Maximum Series Fuse Rating	20 A
Module Efficiency η_m (%)	19.7 %

STC: Irradiance 1000 W/m², Cell Temperature 25 °C, Air Mass AM = 1.5

MECHANICAL DATA

Solar Cells	Monocrystalline 160 × 178 mm (6.3 × 7 in)
Module Dimensions	58.7 × 26.8 × 1.2 in (1490 × 680 × 30 mm)
Cell Orientation	32 cells (4 × 8)
Weight	23.6 lb (10.7 kg)
Glass	3.2 mm (0.13 in), High Transmission, AR Coated Tempered Glass
Backsheet	White
Connector	Solar Connectors
Frame	Anodized Aluminum Alloy
Junction Box	IP 67 rated
Cables	Photovoltaic Technology Cable 4.0 mm ² (#12 gauge), 35.4 in (900 mm) Length

TEMPERATURE RATINGS

Operating Temperature	-40°C ~ +85°C
Nominal Module Operating Temperature (NMOT)	45°C ± 2°C
Temperature Coefficient of PMAX	-0.39%/°C
Temperature Coefficient of VOC	-0.29%/°C
Temperature Coefficient of ISC	0.05%/°C

CURVE CHARACTERISTICS

