

MEGA 200 MAX

Monocrystalline Solar Panel

200W

Maximum Power Output

64 CELLS

Monocrystalline Module

0~+5W









Positive Power Tolerance

19.7%

Maximum Efficiency



FEATURES

-  9 busbar solar cell configuration
-  Lightweight anodized aluminum frame
-  Plug and play junction box
-  High transmission, AR (anti-reflective) coated tempered glass
-  Industry standard quick connect cables (Solar Connectors) work in series or in parallel
-  Excellent low light performance on cloudy days, mornings and evenings
-  Highly reliable due to stringent quality control (Over 30 in-house tests (UV, TC, HF, and many more), PID resistant, 100% EL double inspection)
-  Certified to withstand challenging environmental conditions (2400 Pa wind load, 5400 Pa snow load, 35 mm hail stones at 97 km/h)

INSTALLATION

- Easy installation and handling for various applications (high-end off-grid and mobile applications).
- Pre-drilled holes compatible with ground mounts, Z brackets, pole mounts and tilt mounts.
- Compatible with on-grid and off-grid inverters.

WARRANTY

- 25 years warranty limited output power
- * (Please refer to product warranty for details)

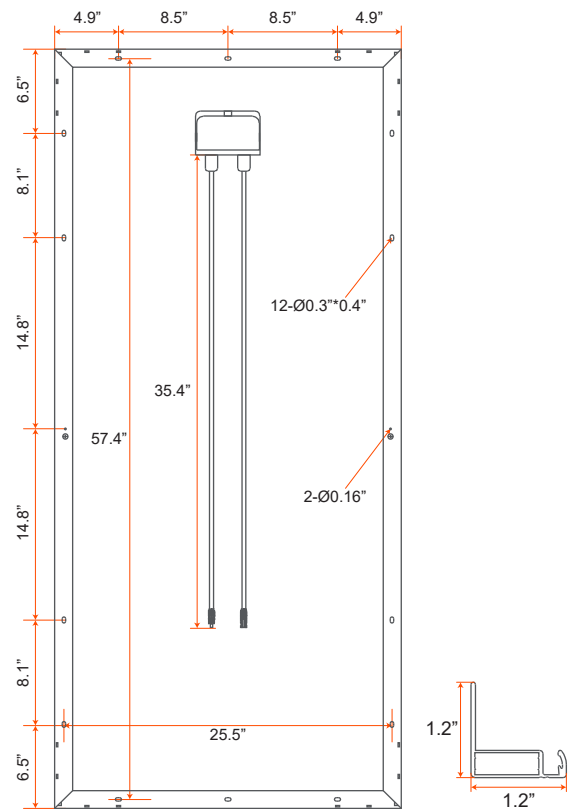
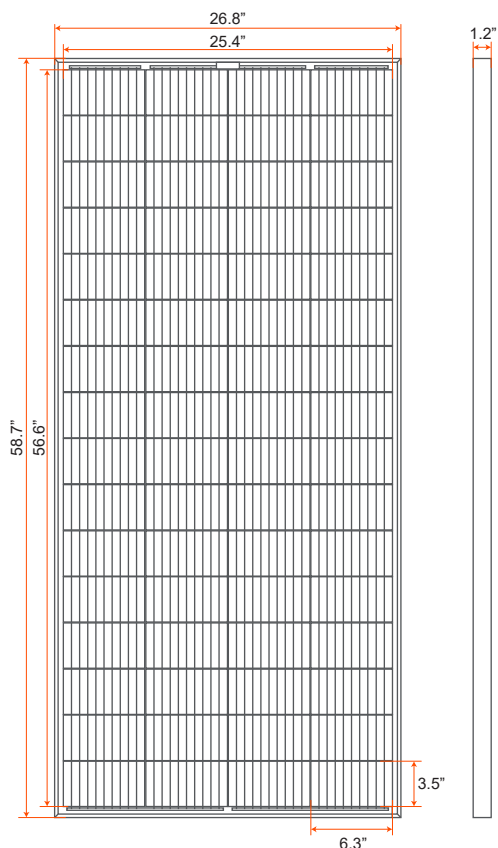

ELECTRICAL DATA (STC)

| | |
|---------------------------------|----------|
| Peak Power Watts-PMAX (Wp) | 200 W |
| Power Output Tolerance-PMAX (W) | 0~+5 W |
| Maximum Power Voltage-VMPP (V) | 36.3 V |
| Maximum Power Current-IMPP (A) | 5.51 A |
| Open Circuit Voltage-VOC (V) | 43.5 V |
| Short Circuit Current-ISC (A) | 5.93 A |
| Maximum System Voltage | 1000 VDC |
| Maximum Series Fuse Rating | 15 A |
| Module Efficiency η_m (%) | 19.7 % |

STC: Irradiance 1000 W/m², Cell Temperature 25 °C, Air Mass AM = 1.5

MECHANICAL DATA

| | |
|-------------------|--|
| Solar Cells | Monocrystalline 6.3 × 3.5 in (160 × 89 mm) |
| Module Dimensions | 58.7 × 26.8 × 1.2 in (1490 × 680 × 30 mm) |
| Cell Orientation | 64 cells (4 × 16) |
| Weight | 23.6 lb (10.7 kg) |
| Glass | 3.2 mm (0.13 in), High Transmission, AR Coated Tempered Glass |
| Backsheet | White |
| Connector | Solar Connectors |
| Frame | Anodized Aluminum Alloy |
| Junction Box | IP 67 rated |
| Cables | Photovoltaic Technology Cable 4.0 mm ² (#12 gauge), 35.4 in (900 mm) Length |

TEMPERATURE RATINGS

| | |
|---|---------------|
| Operating Temperature | -40°C ~ +85°C |
| Nominal Module Operating Temperature (NMOT) | 45°C ± 2°C |
| Temperature Coefficient of PMAX | -0.39%/°C |
| Temperature Coefficient of VOC | -0.29%/°C |
| Temperature Coefficient of ISC | 0.05%/°C |

CURVE CHARACTERISTICS

