



Lithium Battery Charger User Manual

Model: SE-C1220

Thank you very much for choosing SUNRICH ENERGY lithium battery charger!
In order to help you use, store and maintain the lithium battery of our company,
please read and understand this user manual carefully before use.



- 02** **PRODUCT OVERVIEW**
- 04** **HOW TO CONNECT**
- 05** **LED INDICATOR**
- 05** **SPECIFICATIONS**
- 06** **CHARGING MODES**
- 07** **MAINTENANCE & USE PRECAUTIONS**
- 08** **TROUBLESHOOTING**
- 09** **AFTER-SALE SERVICE**

PRODUCT OVERVIEW

14.4V 20A LITHIUM BATTERY CHARGER

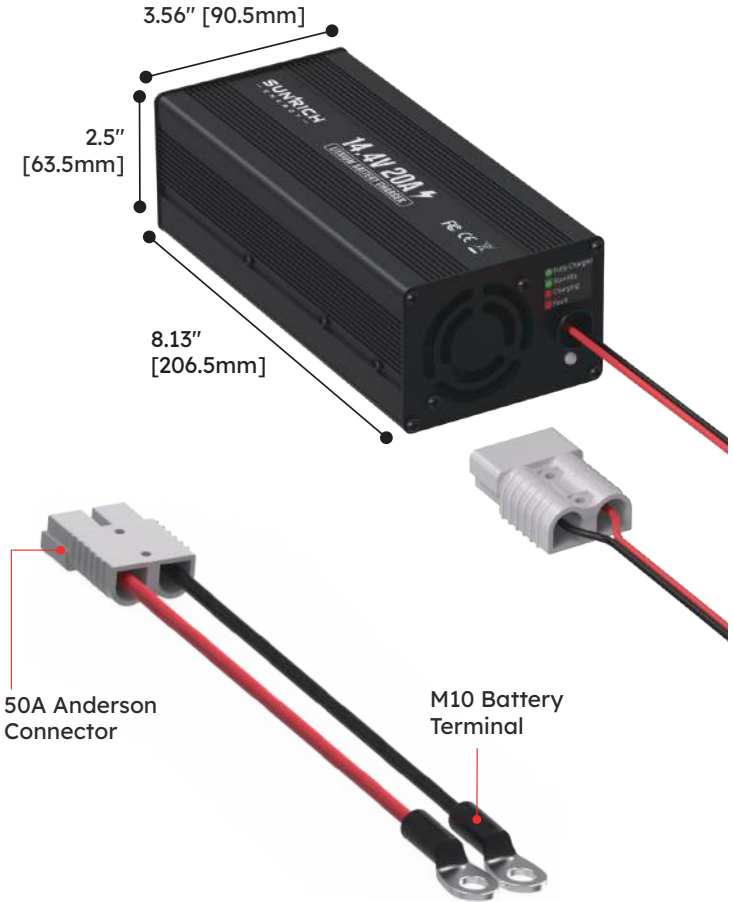

AC SIDE

AC Port



DC SIDE

LED Indicator



HOW TO CONNECT

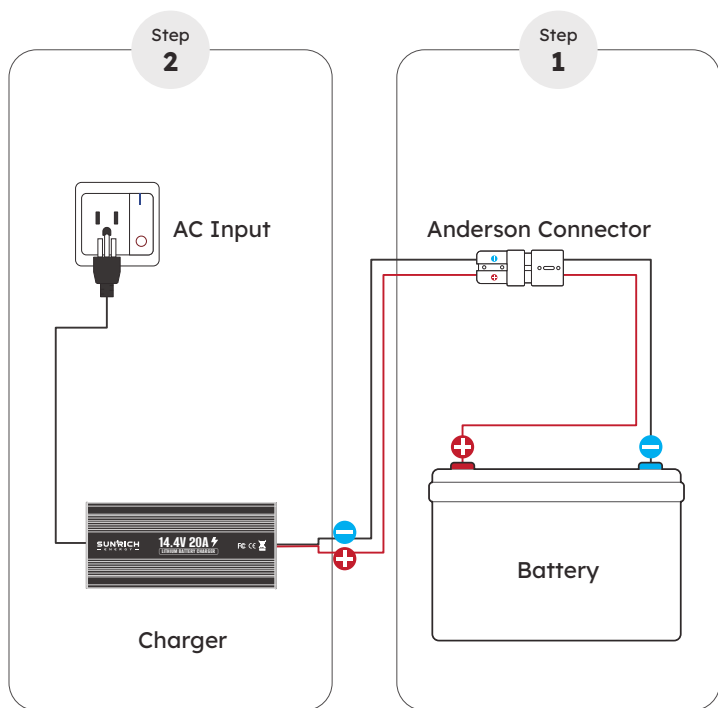





Step 1 Connect the DC output cable to the battery, **+** to **+**, **-** to **-**, then connect the Anderson connector.

Step 2 Connect the AC input cable to the AC port and then to the grid power.

Step 3 Disconnect the Anderson connector or the grid power after charging is complete.

LED INDICATOR

LED Status	Charger Status
 LED Always on Red	Battery is charging
 LED Always on Green	Battery is fully charged
 LED Flashes Green	Charger is on standby
 LED Flashes Red	Charger fault or under protection (overtemperature protection, output short-circuit protection, reverse polarity connection protection, output over-voltage protection).

SPECIFICATIONS

Input Voltage	100V to 240V AC; 50Hz to 60Hz
Max Input Current	7A
Output Voltage	14.4V DC
Output Current	20A
Temperature Range	Operating: -20°C to 40°C/-4°F to 104°F Storage: -40°C to 70°C/-40°F to 158°F
Dimensions	L8.13xW3.56xH2.5 in L206.5xW90.5xH63.5 mm
Net Weight	1.3kg/2.87lb

CHARGING MODES

PRE-CHARGE STAGE (T1)

When the battery voltage is lower than its normal standard and cannot withstand high-current charging, the charger will charge it at a limited current.

This charging mode will be able to activate and repair the battery and extend the battery's lifetime. When the output voltage reaches the normal value, the charger will automatically switch to the next stage.

CONSTANT CURRENT CHARGING STAGE (T2)

When the battery is in the main charging time, the charger will charge the battery with a 20A current, When the battery voltage rises above the set value, the charger will automatically switch to the next stage.

CONSTANT VOLTAGE CHARGING STAGE (T3)

The charger switches to the Constant Voltage Charging Stage and the charging current gradually decreases. When the charging voltage or current reaches the set value, the charger automatically turns off the output voltage and the battery charging is completed.

Voltage & Current

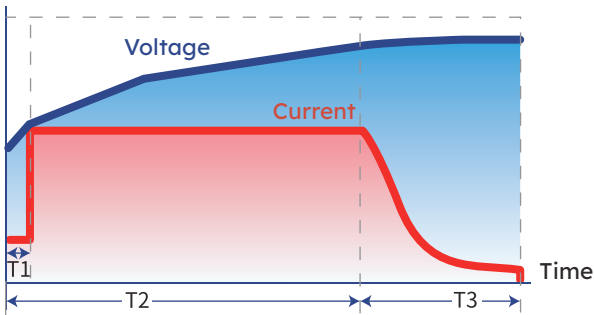

* The charging curves are as above

MAINTENANCE & USE PRECAUTIONS

1. Check the battery specifications carefully before charging to ensure that the Lithium battery matches the charger technical data.
2. Make sure the charger is properly connected to the battery (⊕ to ⊕, ⊖ to ⊖) to avoid a short circuit.
3. The input/output connectors must be firmly connected during charging.
4. Unplug the input/output cable of the charger immediately once the charger or battery is found to be abnormal or damaged during charging.
5. **Do not** use other input cables or extend the output connection cable personally, or please contact SUNRICH at support@sunrichenergy.com to get some advice if you need it.
6. **Do not** open, dismantle, or modify the charger.
7. Never use it in a thunderstorm.
8. Please keep the charger and battery away from water, heat sources, sparks, flames, flammable gas, and hazardous chemicals.
9. **Do not** place rods or other metal objects in vents or other openings.
10. Place the charge in a well-ventilated area with sufficient heat dissipation to prevent overheating and damage.
11. **Do not** puncture, drop, crush, burn, penetrate, shake, strike, or throw it with force.

TROUBLESHOOTING

If the charger does not work properly, the following methods can help you solve the general problem quickly. If you still cannot rule out the possibility of failure, please contact SUNRICH at support@sunrichenergy.com.

Problem	Possible Cause	Solution
LED flashes red when charging.	Under Over Temperature Protection	Cool down the charger to normal temperature, and the charger will resume charging.
LED flashes red after connected.	Under Reverse Polarity Connection Protection / Output Short-Circuit Protection	Connect the charger to the battery correctly, + to + , - to - .
	Under Output Over-Voltage Protection	Make sure the connected battery is a 12.8V Lithium battery.
The charger does not charge and the LED is off after being connected to grid power.	Ac port is not tightly or correctly connected.	Reconnect the AC input cable to the AC input port tightly.
	Charger Internal Damage	Contact us support@sunrichenergy.com for further solutions.

AFTER-SALE SERVICE

Phone: 1-800-850-9978

Email: support@sunrichenergy.com

Address(Office & Warehouse): 2050 S Carlos Ave, Ontario, CA
91761 United States

Website: www.sunrichenergy.com



SUNRICH ENERGY

Making solar power accessible and
affordable across America.